



**DEPARTMENT OF THE ARMY**

THE INSTITUTE OF HERALDRY  
9325 GUNSTON ROAD, ROOM S113  
FORT BELVOIR, VIRGINIA 22060-5579

AAMH-IHS

14 December 2018

MEMORANDUM FOR Commander, 41st Field Artillery Brigade, ATTN: SGT Michael Burns, East Camp Grafenwohr, Germany APO AE 09114

SUBJECT: Heraldic Authorizations for the 41st Field Artillery Brigade

1. As a result of the redesignation of the 41st Fires Brigade to the 41st Field Artillery Brigade, the distinctive unit insignia (DUI), shoulder sleeve insignia (SSI) and combat service identification badge (CSIB) are redesignated effective 16 September 2018.

a. DUI **originally approved** via TIOH Memo, for the 41st Coast Artillery Regiment on 9 July 1924.

b. SSI **originally approved** via TIOH Memo, for the 41st Field Artillery Brigade on 24 November 1981.

c. CSIB **originally approved** via TIOH Memo, for the 41st Field Artillery Brigade on 10 June 2009.

2. Enclosed are the following items for your record:

a. DUI manufacturing drawing D-3368

b. SSI manufacturing drawing A-1-672

c. CSIB manufacturing drawing C-1047

d. 41st Field Artillery Brigade Information Page

3. The U.S. Army Tank-Automotive and Armaments Command is responsible for the procurement of flags. To obtain your flag, complete DD Form 1348-6 online at [www.heraldry.army.mil](http://www.heraldry.army.mil); citing TIOH Drawing No. 5-1-0310, in the remarks section. POC at the Clothing and Heraldry Office is Ms. Franklin, DSN 444-2515 or COMM (215) 737-2515.

AAMH-IHS

SUBJECT: Heraldic Authorizations for the 41st Field Artillery Brigade

4. This authorization is in accordance with AR 670-1, AR 840-10 and Permanent Order 247-4, dated 4 September 2018. A copy of this letter will become part of your permanent organizational history files.

Encls

CHARLES V. MUGNO  
Director

CF:  
The US Army Center of Military History

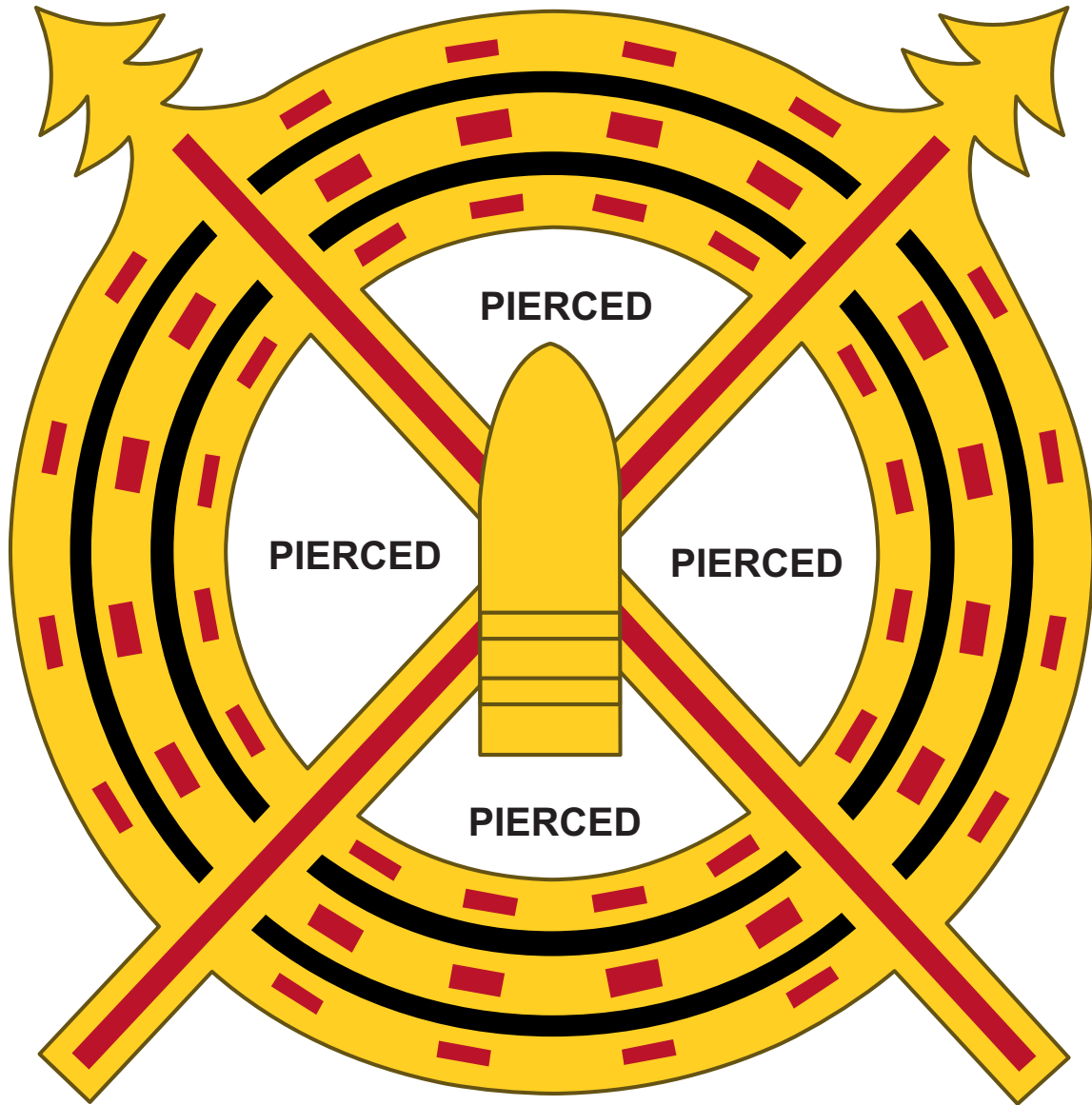

## 41ST FIELD ARTILLERY BRIGADE

**\*\*This Drawing is 6x-Actual Size\*\***

### ACTUAL SIZE

BASE-----1" ± 1/64" High (2.54 cm ± 0.04 cm)

DEVICE----3/8" ± 1/64" High (.95 cm ± 0.04 cm)

### METAL COLOR

& PLATING-----Gold

FINISH-----Mirror-like polish

### DESIGN:

CHARGES-----Flush, except projectile to be superimposed upon center of ring.

DEVICE-----Projectile to be modeled

LETTERING(BASE)-None.

### PIERCING

BASE-----Between ring and diagonally crossed spears.

DEVICE-----None.

EPOXY-----Stoning

### CHIP No's

BASE-----Red #1, Black #26.

DEVICE-----None.

**TYPE V D 3368-X  
BASE & DEVICE (ASSEMBLED)**

***For Color Placement Only  
Not For Color Match***

APPROVED  
THE INSTITUTE OF HERALDRY  
DEPARTMENT OF THE ARMY

**CHARLES V. MUGNO**  
Director

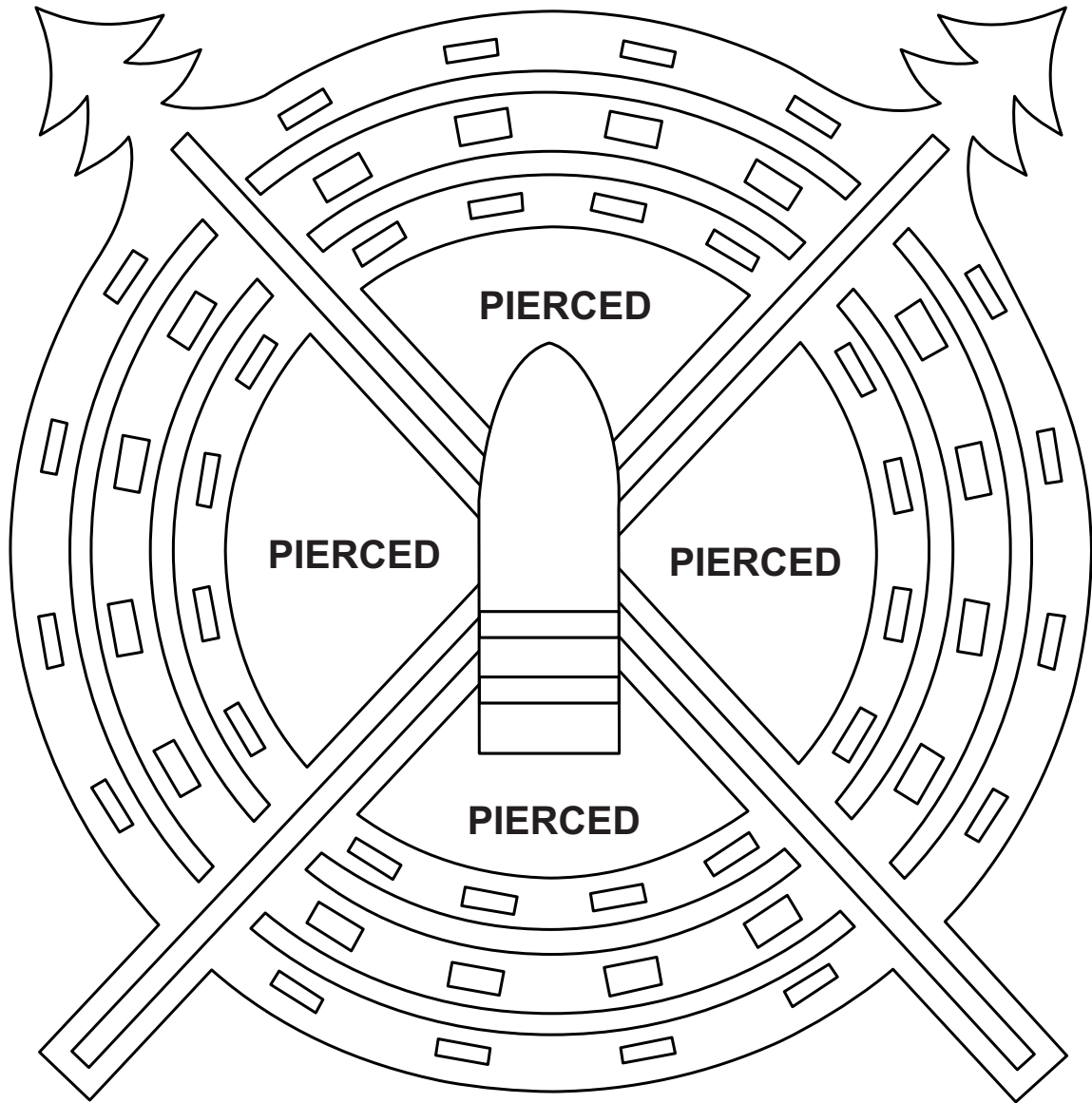

## 41st FIELD ARTILLERY BRIGADE

**\*\*This Drawing is 6x-Actual Size\*\***

### ACTUAL SIZE

BASE-----1"  $\pm$  1/64" High (2.54 cm  $\pm$  0.04 cm)

DEVICE----3/8"  $\pm$  1/64" High (.95 cm  $\pm$  0.04 cm)

### METAL COLOR

& PLATING-----Gold

FINISH-----Mirror-like polish

### DESIGN:

CHARGES-----Flush, except projectile to be superimposed upon center of ring.

DEVICE-----Projectile to be modeled

LETTERING(BASE)-None.

### PIERCING

BASE-----Between ring and diagonally crossed spears.

DEVICE-----None.

EPOXY-----Stoning

### CHIP No's

BASE-----Red #1, Black #26.

DEVICE-----None.

**TYPE V D 3368-X  
BASE & DEVICE (ASSEMBLED)**

APPROVED  
THE INSTITUTE OF HERALDRY  
DEPARTMENT OF THE ARMY

\_\_\_\_\_  
**CHARLES V. MUGNO**  
Director

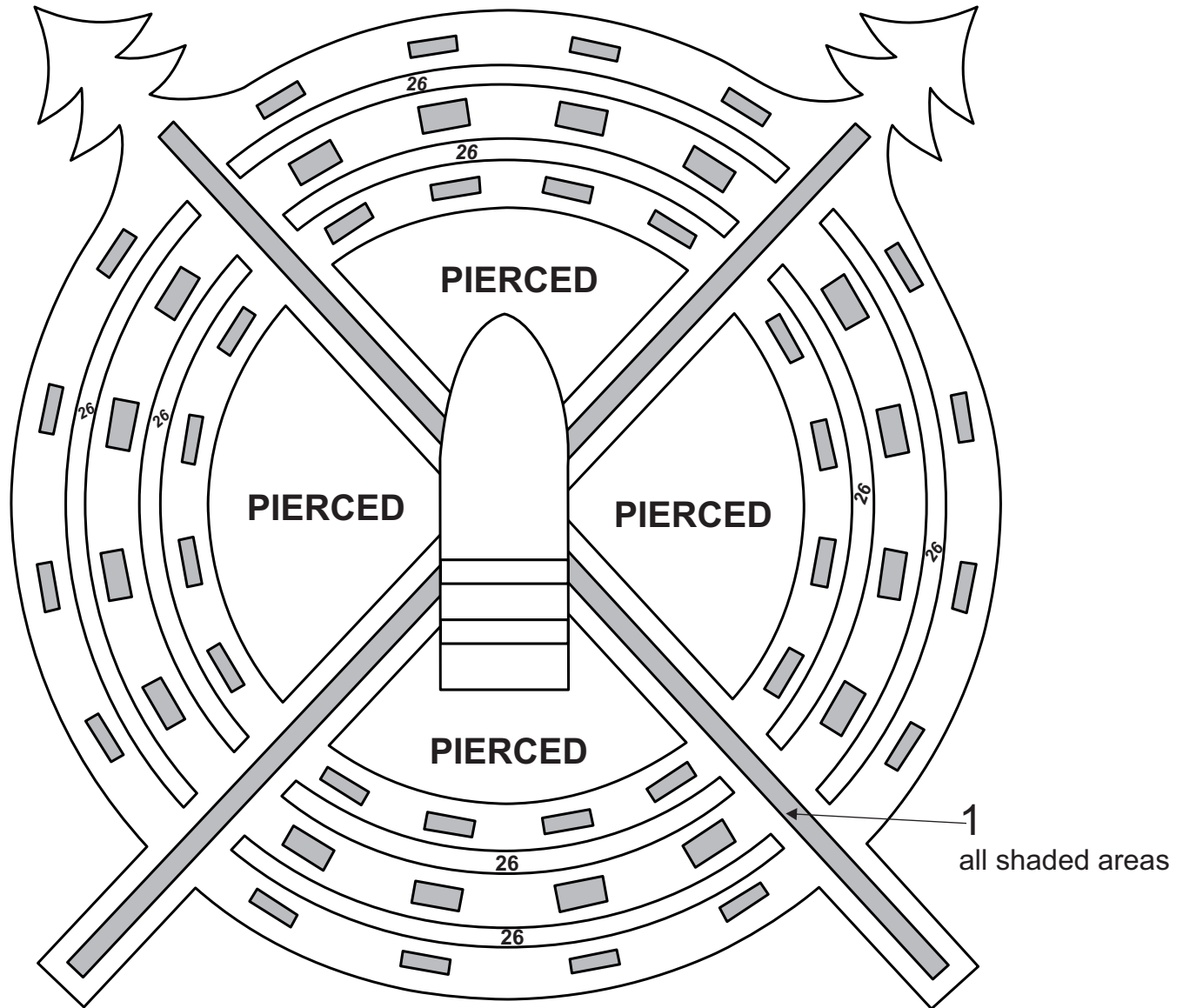

## 41st FIELD ARTILLERY BRIGADE

**\*\*This Drawing is 6x-Actual Size\*\***

### ACTUAL SIZE

BASE-----1" ± 1/64" High (2.54 cm ± 0.04 cm)

DEVICE----3/8" ± 1/64" High (.95 cm ± 0.04 cm)

### METAL COLOR

& PLATING-----Gold

FINISH-----Mirror-like polish

### DESIGN:

CHARGES-----Flush, except projectile to be superimposed upon center of ring.

DEVICE-----Projectile to be modeled

LETTERING(BASE)-None.

### PIERCING

BASE-----Between ring and diagonally crossed spears.

DEVICE-----None.

EPOXY-----Stoning

### CHIP No's

BASE-----Red #1, Black #26.

DEVICE-----None.

## TYPE V D 3368-X BASE & DEVICE (ASSEMBLED)

APPROVED  
THE INSTITUTE OF HERALDRY  
DEPARTMENT OF THE ARMY

CHARLES V. MUGNO  
Director



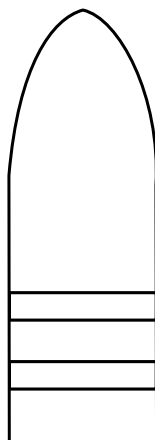

## 41st FIELD ARTILLERY BRIGADE

**\*\*This Drawing is 6x-Actual Size\*\***

### ACTUAL SIZE

DEVICE----3/8" ± 1/64" High (.95 cm ± 0.04 cm)

### METAL COLOR

& PLATING-----Gold

FINISH-----Mirror-like polish

### DESIGN:

#### CHARGES

DEVICE-----Projectile to be modeled & superimposed upon  
center of ring.

LETTERING-----None.

PIERCING-----None

EPOXY-----None

CHIP No's-----None

**TYPE V  
DEVICE**

**D 3368-X**

*APPROVED  
THE INSTITUTE OF HERALDRY  
DEPARTMENT OF THE ARMY*

---

**CHARLES V. MUGNO**  
*Director*

**FOR SUBDUED INSIGNIA**

**OCP:**

**RED AREAS TO BE BLACK 67138. YELLOW  
AREA TO BE BAGBY GREEN 67204**

**REVISIONS**

**FORMERLY: 41ST FIRES BRIGADE**

**SUPERSEDES TIOH DRAWING No. A-1-672 DTD. 3 JANUARY 2003**

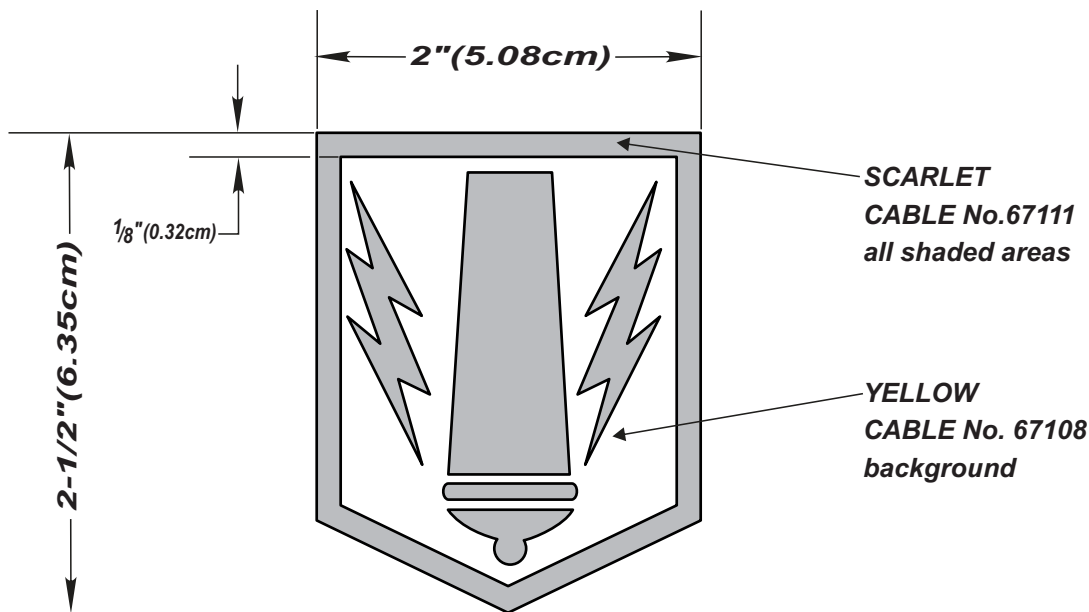

**DESIGNED FOR OVEREDGE STITCHING**

**STITCH COUNT**

**5528 STITCHES (MINIMUM)**

**100/2 DENIER**

**8/4 SPAN**

EXAMINED	<i>TLC</i>	
CHECKED	<i>CA</i>	<i>SAO</i>
PREPARED	<i>CAlford</i>	
APPROVED	<p style="text-align: center;">_____ <b>CHARLES V. MUGNO</b> DIRECTOR</p>	
MATERIALS: TO BE MANUFACTURED IN ACCORDANCE WITH MIL-DTL-14652		

**THE INSTITUTE OF HERALDRY, DEPARTMENT OF THE ARMY**  
9325 GUNSTON RD, RM S-113 FORT BELVOIR, VA 22060-5579

**SHOULDER SLEEVE INSIGNIA**  
**41ST FIELD ARTILLERY**  
**BRIGADE**

SIZE	CONTROL IDENT. NO
<b>A</b>	<b>22571</b>

**A - 1 - 672**

SCALE	FULL	DATE	<b>4 DECEMBER 2018</b>
-------	------	------	------------------------



**41ST FIELD ARTILLERY BRIGADE**

**\*\*This Drawing is 3x-Actual Size\*\***

ACTUAL SIZE-----2" ± 1/64" High (5.08 cm ± 0.04 cm)

METAL COLOR  
AND PLATING-----Gold  
FINISH-----Mirror-like polish

DESIGN:  
CHARGES-----Flush.  
LETTERING-----None  
PIERCING-----None  
PRONGS-----Three (3)  
EPOXY-----Stoning

CHIP No's-----Red #1, Yellow #31

**TYPE I      C - 1047**

***For Color Placement Only  
Not For Color Match***

APPROVED  
THE INSTITUTE OF HERALDRY  
DEPARTMENT OF THE ARMY

---

**CHARLES V. MUGNO**  
Director

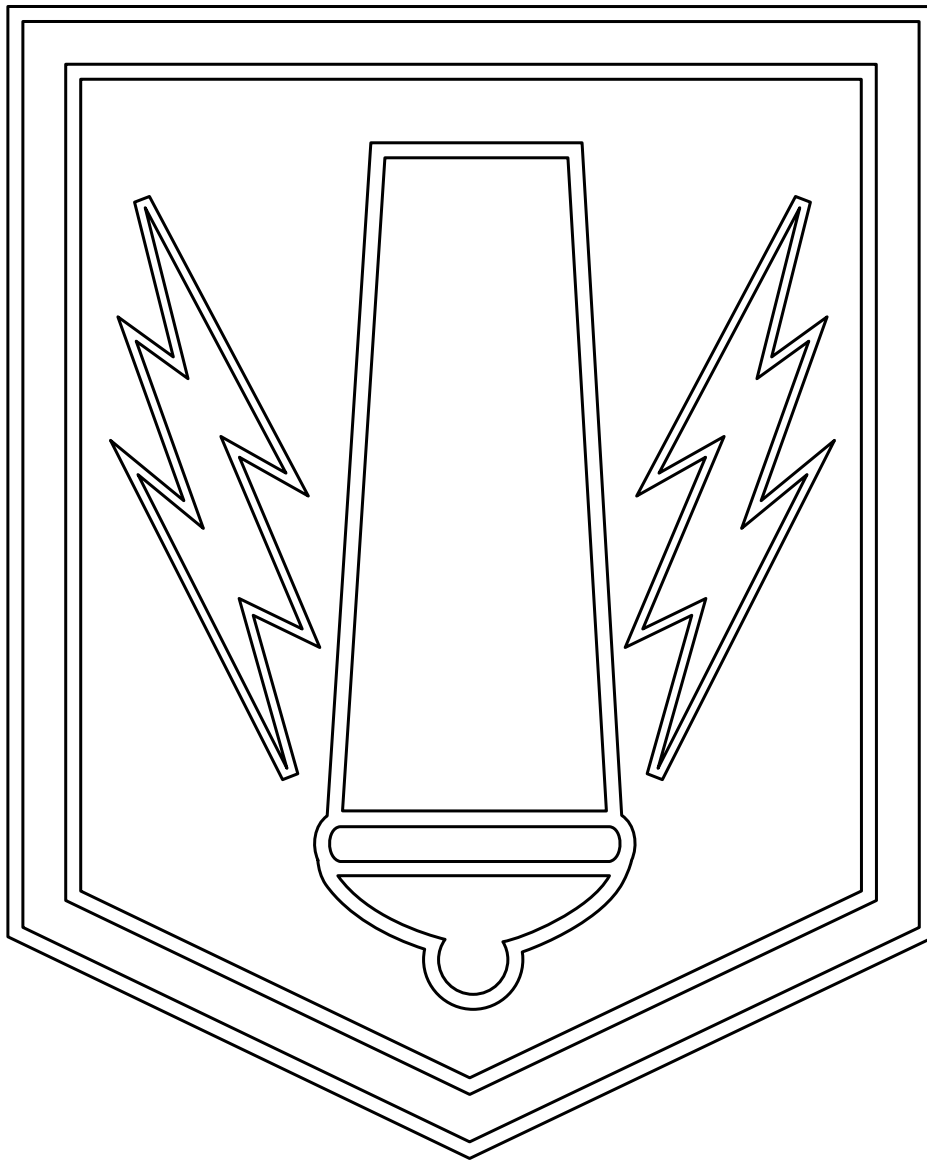

**41st FIELD ARTILLERY BRIGADE**

**TYPE I C - 1047**

**\*\*This Drawing is 3x-Actual Size\*\***

ACTUAL SIZE-----2" ± 1/64" High (5.08 cm ± 0.04 cm)

METAL COLOR  
AND PLATING-----Gold  
FINISH-----Mirror-like polish

DESIGN:  
CHARGES-----Flush.  
LETTERING-----None  
PIERCING-----None  
PRONGS-----Three (3)  
EPOXY-----Stoning

*APPROVED  
THE INSTITUTE OF HERALDRY  
DEPARTMENT OF THE ARMY*

CHIP No's-----Red #1, Yellow #31

---

**CHARLES V. MUGNO**  
*Director*

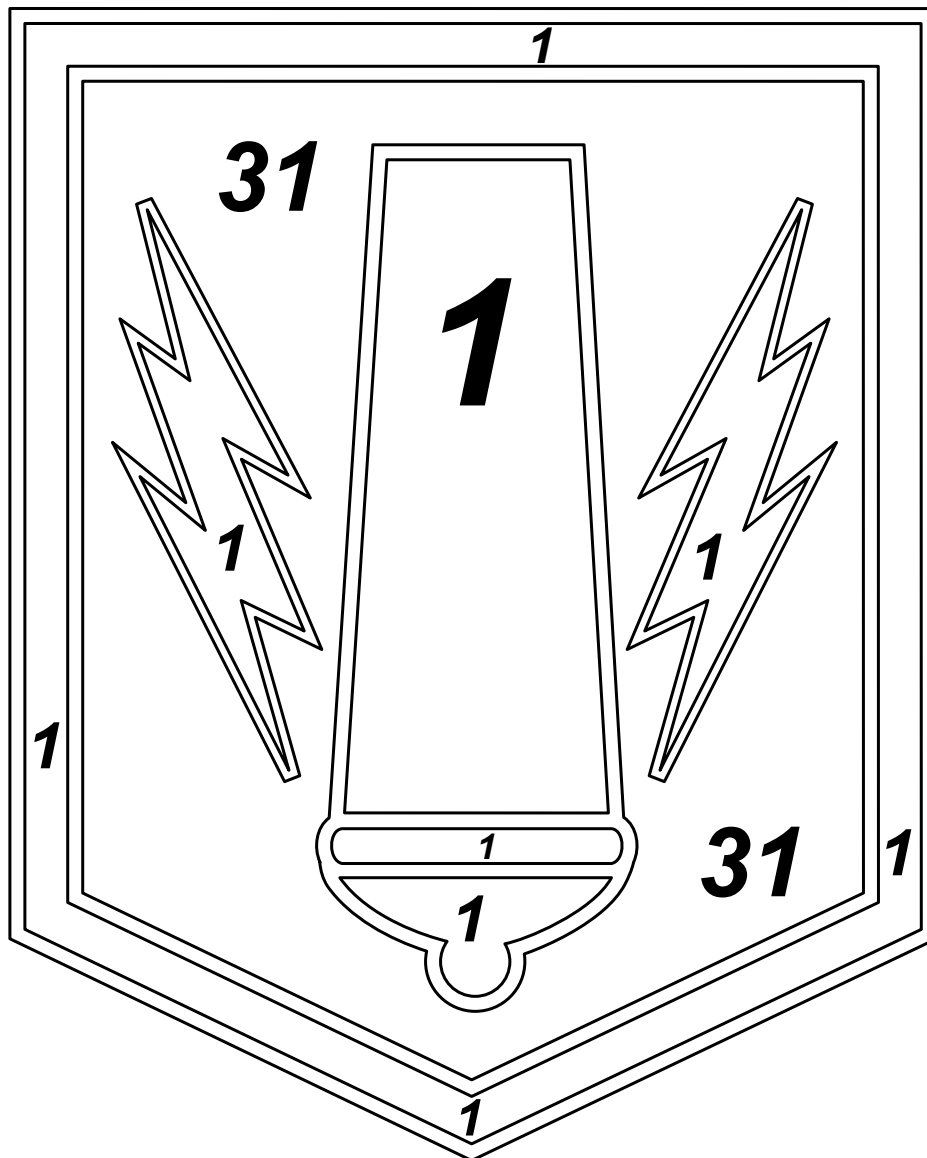

**41st FIELD ARTILLERY BRIGADE**

**TYPE I C - 1047**

**\*\*This Drawing is 3x-Actual Size\*\***

ACTUAL SIZE-----2" ± 1/64" High (5.08 cm ± 0.04 cm)

METAL COLOR  
AND PLATING-----Gold  
FINISH-----Mirror-like polish

DESIGN:  
CHARGES-----Flush.  
LETTERING-----None  
PIERCING-----None  
PRONGS-----Three (3)  
EPOXY-----Stoning

APPROVED  
THE INSTITUTE OF HERALDRY  
DEPARTMENT OF THE ARMY

CHIP No's-----Red #1, Yellow #31

**CHARLES V. MUGNO**  
Director

## 41ST FIELD ARTILLERY BRIGADE



**Shoulder Sleeve Insignia**



**Combat Service Identification Badge**



**Distinctive Unit Insignia**

**Shoulder Sleeve Insignia. Description:** On a Yellow vertical square shield-shaped embroidered item with the base coming to a point, 2 inches (5.08 cm) in width and 2 1/2 inches (6.35 cm) in height overall, a red cannon barrel with muzzle upwards between two red lightning bolts; all within an 1/8 inch (.32 cm) red border.

**Symbolism:** Scarlet and yellow are the colors associated with Field Artillery. The gun tube alludes to the howitzers and the flashes symbolize speed, accuracy and shock.

**Background:** The shoulder sleeve insignia was originally approved for the 41st Field Artillery Brigade on 24 November 1981. It was redesignated effective 16 April 2007, for the 41st Fires Brigade with the description updated. Redesignated 16 September 2018 to the 41st Field Artillery Brigade.

(TIOH Dwg. No. A-1-672)

**COMBAT SERVICE IDENTIFICATION BADGE:** A gold color metal and enamel device 2 inches (5.08 cm) in height consisting of a design similar to the shoulder sleeve insignia.

**Distinctive Unit Insignia. Description:** A metal and epoxied device 1 inch (2.54 cm) in diameter overall consisting of a circular stylized railroad track, on a gold ring, rails black and cross ties red, superimposed thereon two Hawaiian spears diagonally crossed, shafts red and spearheads gold and upward, with a gold mortar projectile, centered upon the spears.

**Symbolism:** Scarlet and yellow (gold) are the colors for Field Artillery organizations. The predecessor organization, the 41st Coast Artillery Regiment, was the Hawaiian railway regiment, which is represented by the track, Hawaiian spears and projectile.

**Background:** The distinctive unit insignia was originally approved for the 41st Coast Artillery Regiment on 9 July 1924. It was redesignated for the 41st Artillery Group on 2 February 1966. On 7 April 1972, the insignia was redesignated for the 41st Field Artillery Group. The insignia was redesignated for the 41st Field Artillery Brigade effective 16 June 1982. It was redesignated effective 16 April 2007, for the 41st Fires Brigade with the description updated. Redesignated 16 September 2018 to the 41st Field Artillery Brigade.